









For Drums with Hazardous Substances







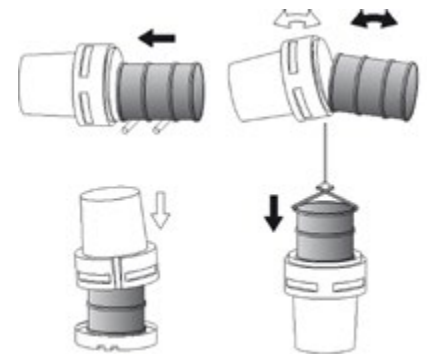

- ▶ Quick containment and leak-proofing of damaged containers when isolating hazardous substances.
- ▶ Safety container with UN code meeting the requirements for handling and transporting hazardous substances.
- ▶ The material can withstand most chemicals.

Type 4387	Type 4388	Type 4389
 75 l	 115 l	 360 l
 Ø 570 × 490 mm	 Ø 550 × 760 mm	 Ø 800 × 1050 mm
 5 kg	 6 kg	 22 kg



For Hazardous Substances

- ▶ Made of polyethylene.
- ▶ Screw lid ensures a perfect seal (secured against spontaneous bulking).
- ▶ Certified for storage and transport of hazardous substances.
- ▶ Stackable.
- ▶ Easy to seal.

Type 4413	Type 4414	Type 4415
 15 l	 20 l	 25 l
 Ø 345 × 297 mm	 Ø 345 × 385 mm	 Ø 345 × 460 mm
 1 kg	 1.3 kg	 1.5 kg

