









Na sudy s nebezpečnými látkami







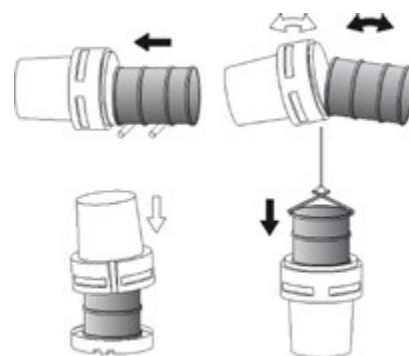

- ▶ Rýchle zabezpečenie a nepriepustné uzatvorenie poškodených nádob pri izolovaní nebezpečných látok.
- ▶ Bezpečnostný prepravný obal s UN kódom spĺňa požiadavky na manipuláciu a prepravu nebezpečných látok.
- ▶ Materiál odoláva väčšine chemických látok.

Typ 4387	Typ 4388	Typ 4389
 75 l	 115 l	 360 l
 Ø 570 × 490 mm	 Ø 550 × 760 mm	 Ø 800 × 1050 mm
 5 kg	 6 kg	 22 kg



Na nebezpečné látky

- ▶ Vyrobené z polyetylénu.
- ▶ Skrutkovacie veko zaisťuje dokonalé tesnenie (zabezpečené poistkou proti samovoľnému uvoľneniu).
- ▶ Certifikované na skladovanie a prepravu nebezpečných látok.
- ▶ Možnosť stohovania.
- ▶ Možnosť ľahko zaplombovať.

Typ 4413	Typ 4414	Typ 4415
 15 l	 20 l	 25 l
 Ø 345 × 297 mm	 Ø 345 × 385 mm	 Ø 345 × 460 mm
 1 kg	 1,3 kg	 1,5 kg

